

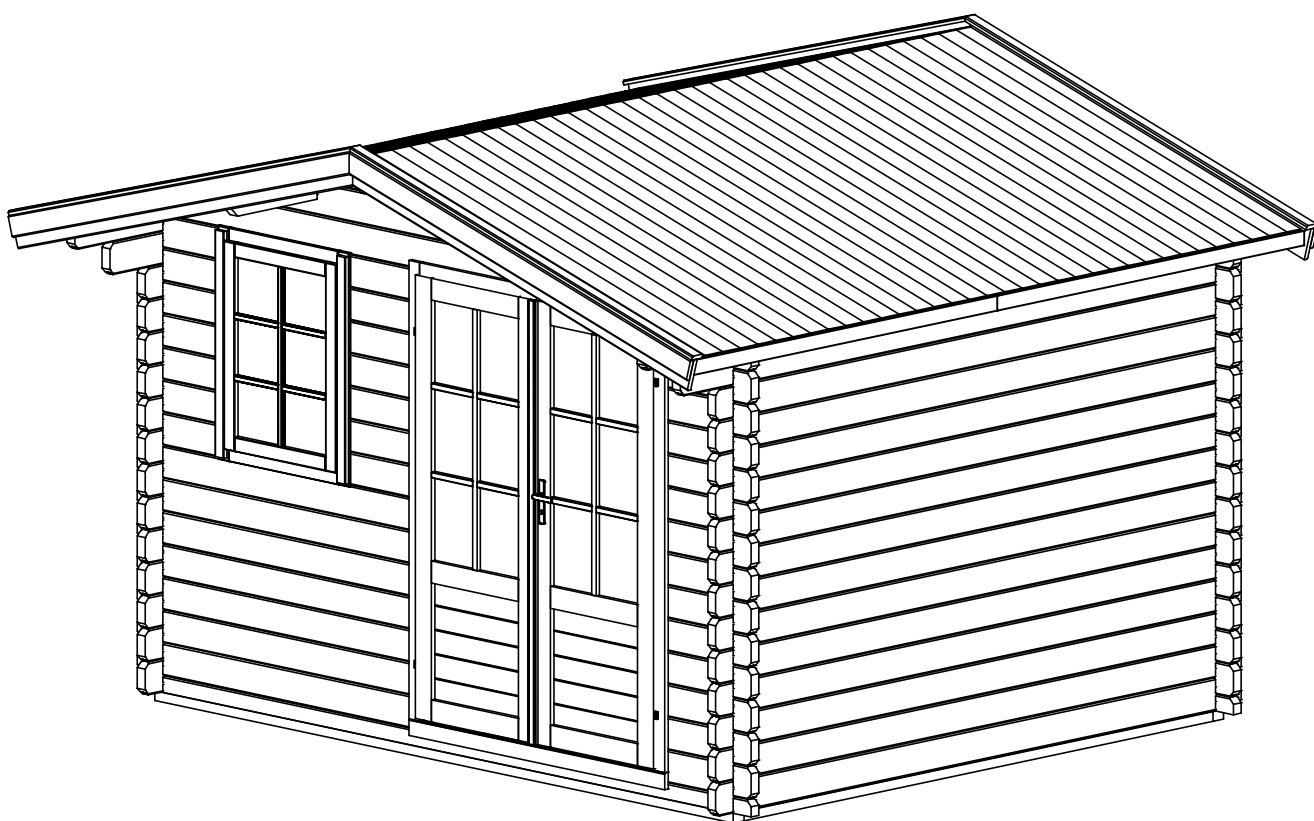







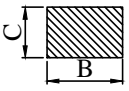
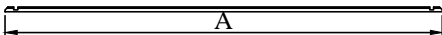
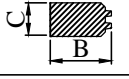

AUFBAUANLEITUNG
PRUNES 7
3.48 x 2.48 m, 34mm

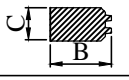

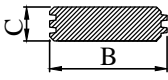
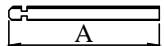
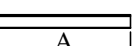
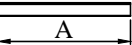
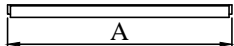

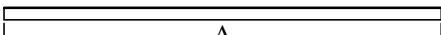
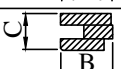
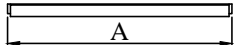
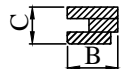
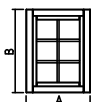
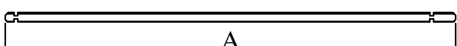
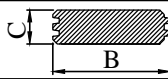

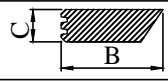
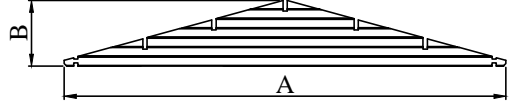
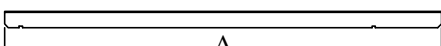
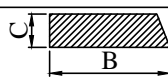
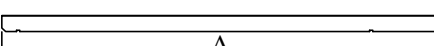
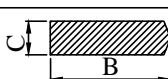
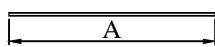
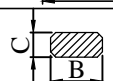
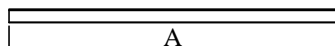
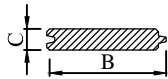

STÜCKLISTE

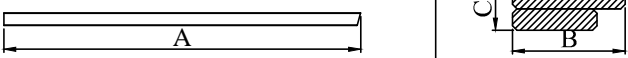
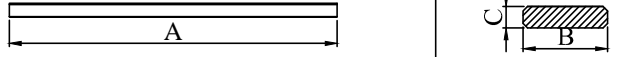
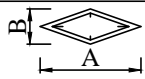
Nr.	Menge	Abmessungen, mm			Details	
		A	B	C		
1	x 2	3280	60	40		
2	x 2	2160	60	40		
3	x 1	3480	67	34		
3a	x 1	3480	67	34		
4	x 26(+1)	2480	135	34		
5	x 14(+1)	3480	135	34		
6	x 7	1570	135	34		
7	x 21	490	135	34		
8	x 7	365	135	34		
9a	x 1	1410	120	60		
9b	x 1+1	1955	120	90		
9c	x 1	1410	120	90		
10	x 1	1035	775			
11	x 2	2630	135	34		
12	x 1+1	2980	135	34		
13	x 2	3477	534	34		
14	x 1+1	2980	140	44		
15	x 1	2980	140	44		
16	x 4	2030	40	16		
17	x68(+2)	1950	88	17		

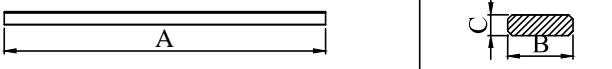
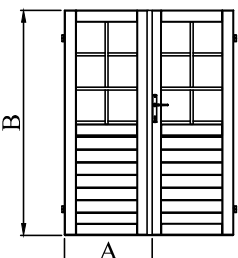
Die Zahlen in Klammern bedeuten die Stückzahl von Ersatzteilen, im Falle einer fehlerhaften Lieferung.

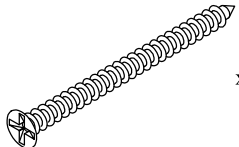
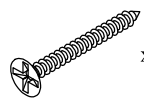
STÜCKLISTE

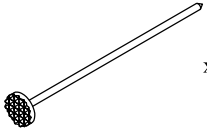
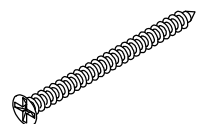
Nr.	Menge	Abmessungen, mm			Details
		A	B	C	
19	x 2+2	1995	120+90	19	
20	x 4	1995	60	19	
21	x 2	220	100	19	
22	x 6	993	40	40	
23	x 4	1490	60	19	
24	x 1+1	660	1775		

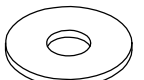
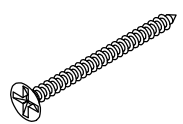
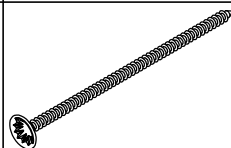
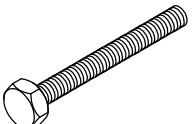
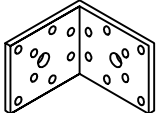
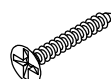
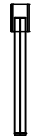
5 x 90 mm	4 x 40 mm	M6	2 x 40 mm
 x 10	 x 20	 x 4	 x 210
5 x 70 mm	3 x 30 mm	M6	
 x 30	 x 52	 x 8	
4 x 50	7,5 x 92	6 x 70	4 x 40
 x 22	 x 8	 x 4	 x 4
5 x 20 mm	ST		
 x 4	 x 2		

Installationshinweise für Ihr Gebäude

1. Bodenplatte. Sie können das Gartenhaus mit Fußboden (a) oder ohne Fußboden (b) bestellen. Legen Sie den Bodenrahmen (a) auf die Bodenplatte (b) auf oder wählen eine weitere Variante. Befestigen Sie den Unterkonstruktionskranz (Perimeter) an Platte mit 8 Stck. Muerschrauben 7,5x92mm (im Set enthalten) entfernt ca. 40 cm von der Eckverbindungsschnittstelle.

Achtung! Die Dichtung ist zwischen der Bodenplatte und der Unterkonstruktion zu verwenden (Bitumenbelag Band). Die Dichtung dient zum Ausgleich und zum Verhindern von der Nässe in die Bodenbalken (im Lieferumfang nicht enthalten).

a)

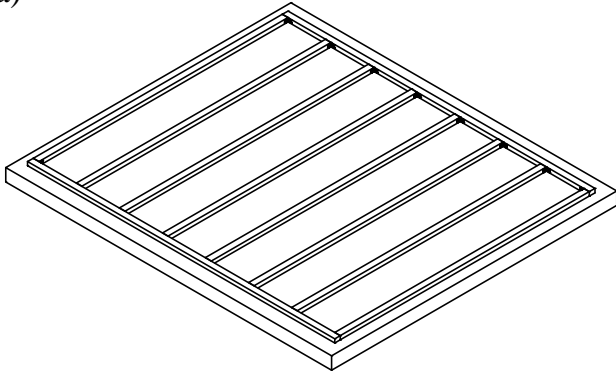

b)

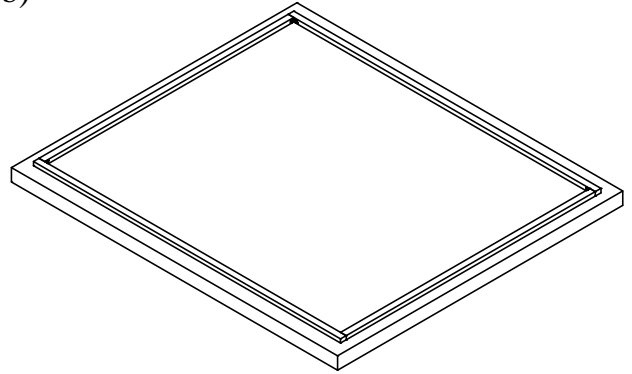

2. Betonblöcke. Im Falle einer Bestellung des Gartenhauses mit Fußboden, ist ein Fundament zu errichten (Siehe Bild) (verschiedene Variante möglich). Befestigen Sie den Unterkonstruktionskranz (Perimeter) an Blöcken mit 8 Stck. Muerschrauben 7,5x92mm (im Set enthalten) entfernt ca. 40 cm von der Eckverbindungsschnittstelle. Die Fußbodenbalken sind mit Metallwinkeln zu befestigen (im Set enthalten).

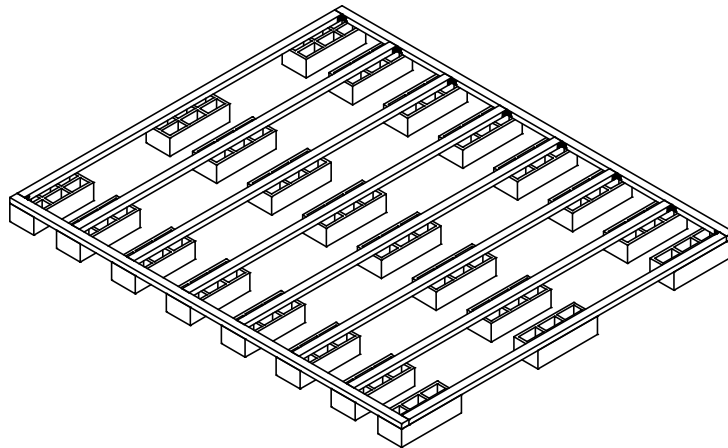

Befestigung von Bodenplatte

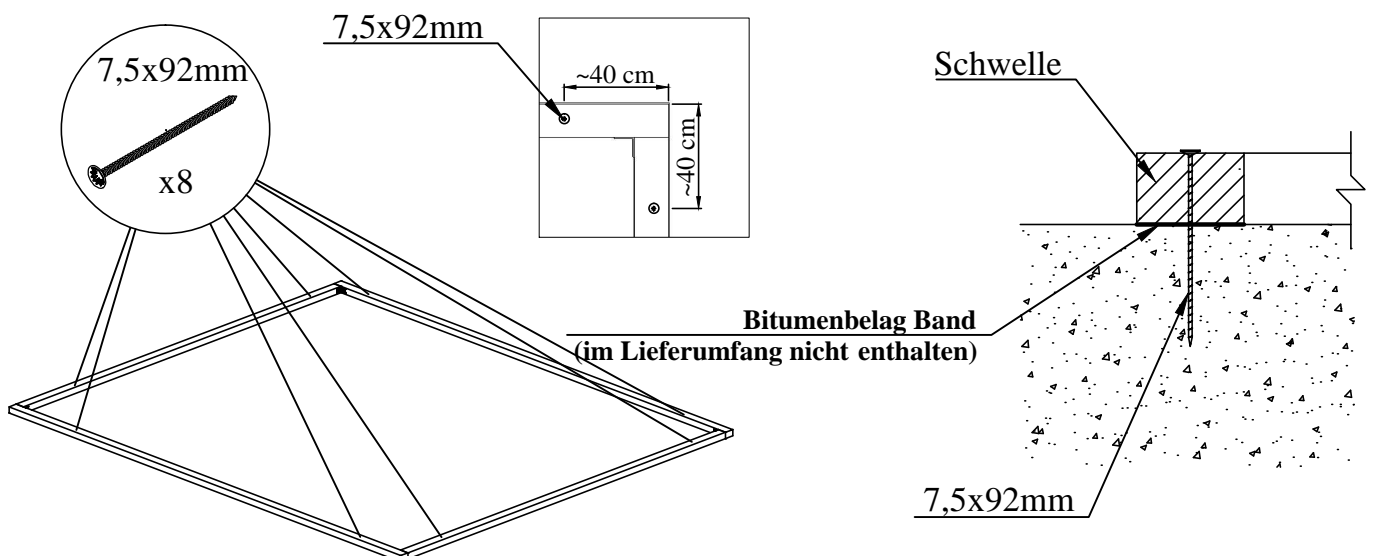

Auflegen von Bodenplatte

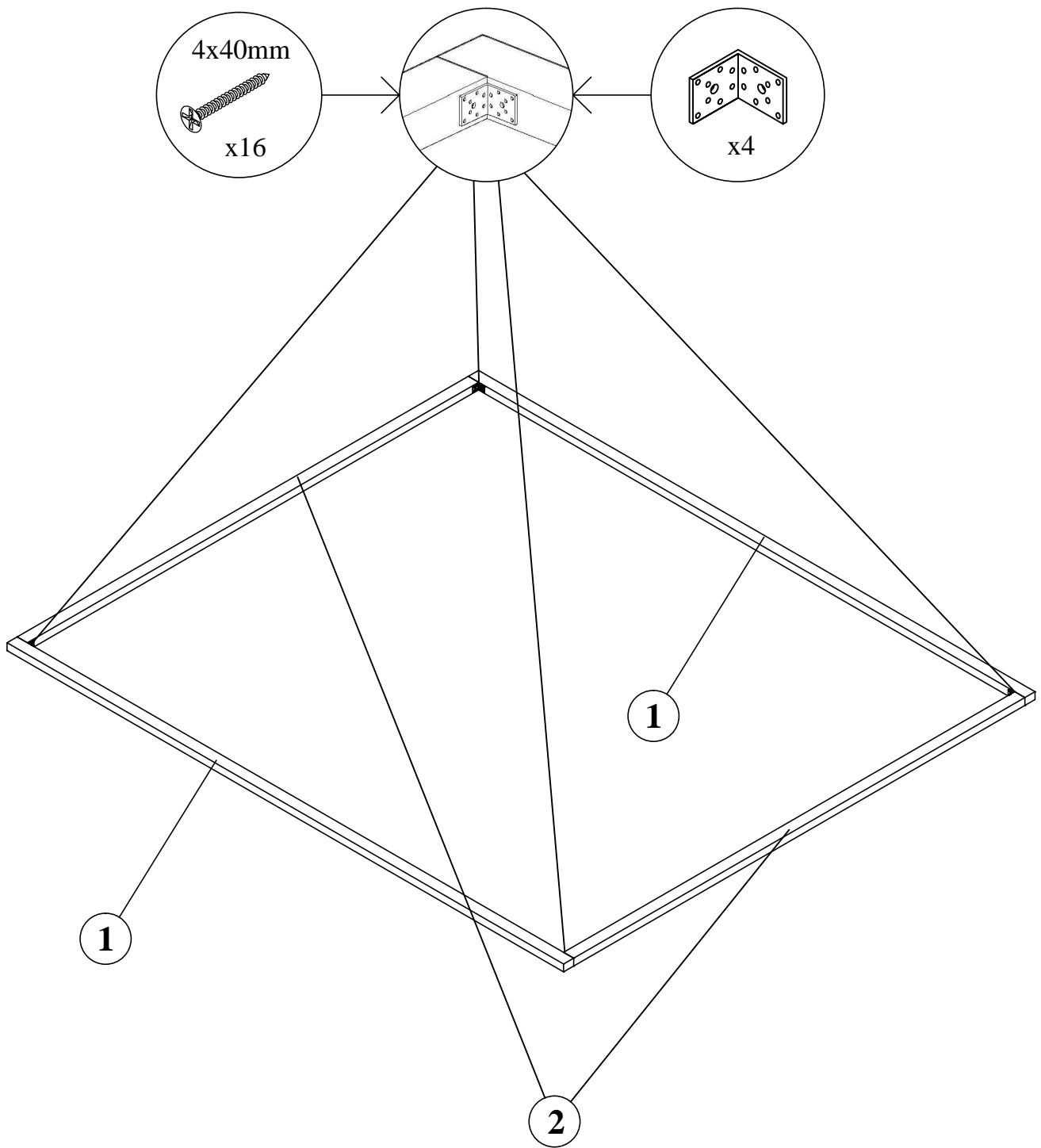

Nr.	Abmessungen (mm)	Menge
1	3280 x 60 x 40	2
2	2160 x 60 x 40	2

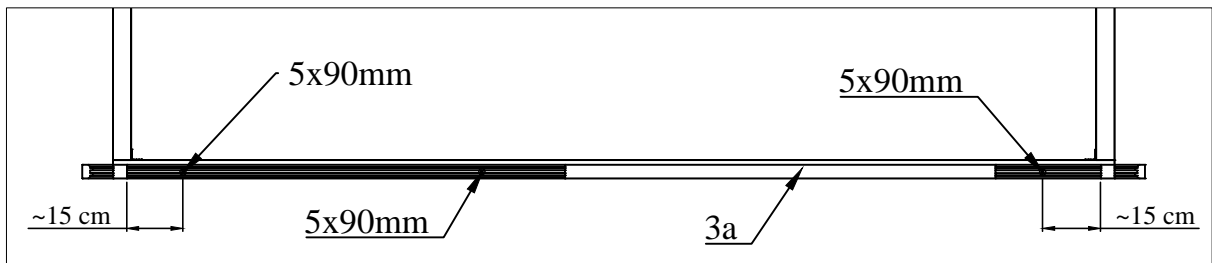
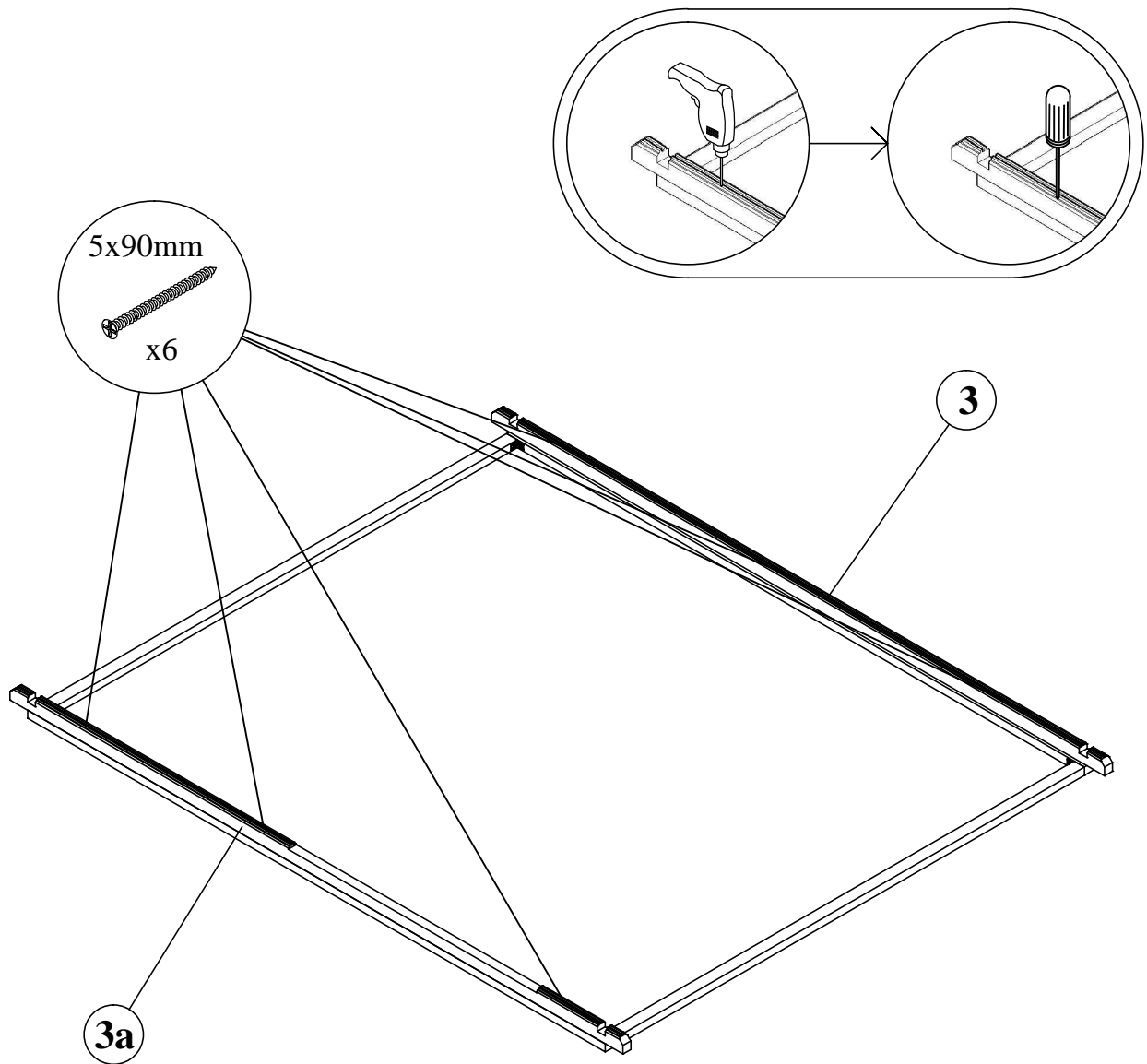

Nr.	Abmessungen (mm)	Menge
3	3480 x 67.5 x 34	1
3a	3480 x 67.5 x 34	1

Montage von Türen und Wänden

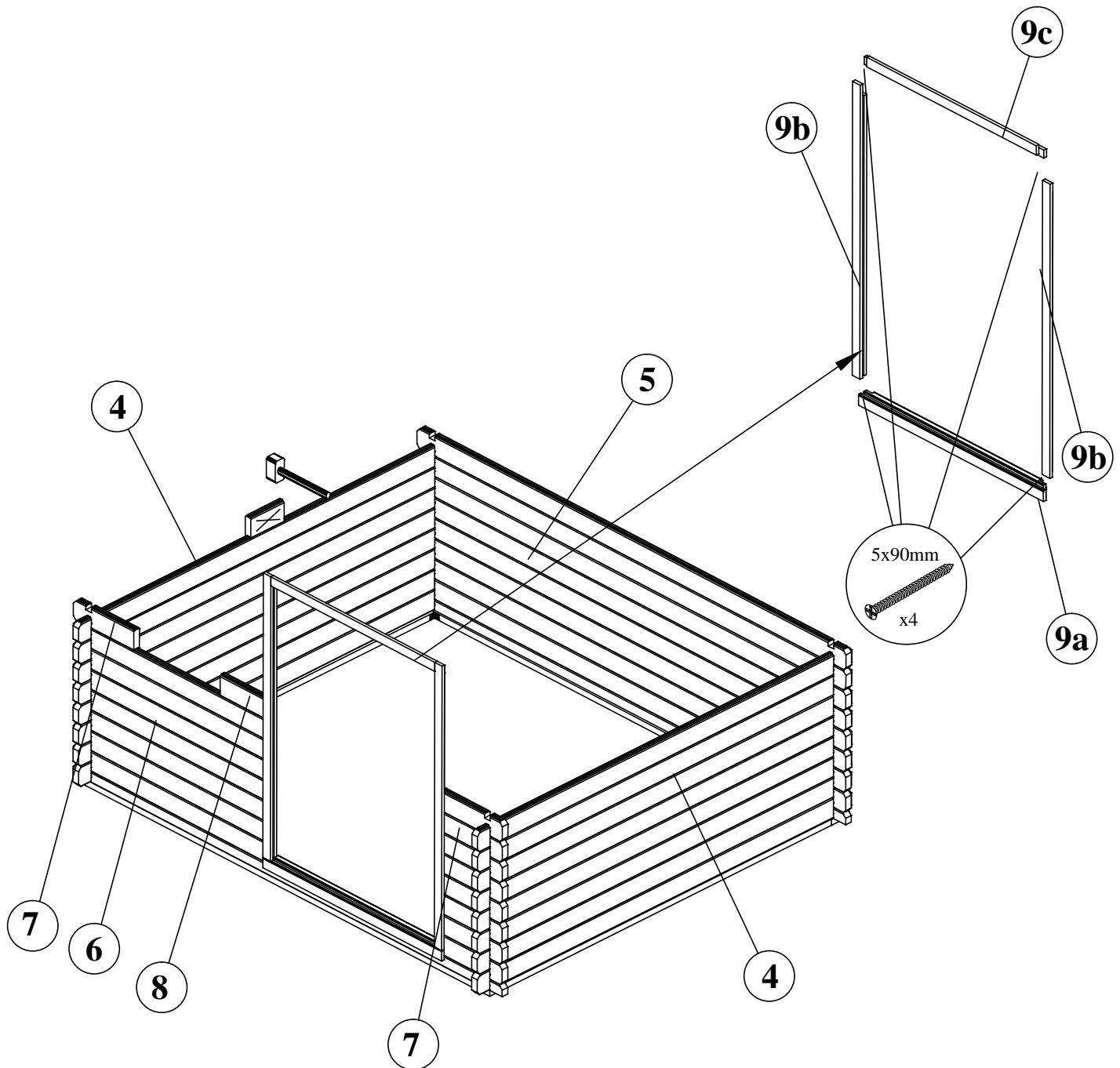

Nr.	Abmessungen (mm)	Menge
4	2480 x 135 x 34	26(+1)
5	3480 x 135 x 34	14(+1)
6	1570 x 135 x 34	7
7	490 x 135 x 34	21
8	365 x 135 x 34	7
9a	1410 x 60 x 120	1
9b	1955 x 90 x 120	1+1
9c	1410 x 90 x 120	1

Montage von Fenstern und Dachbalken

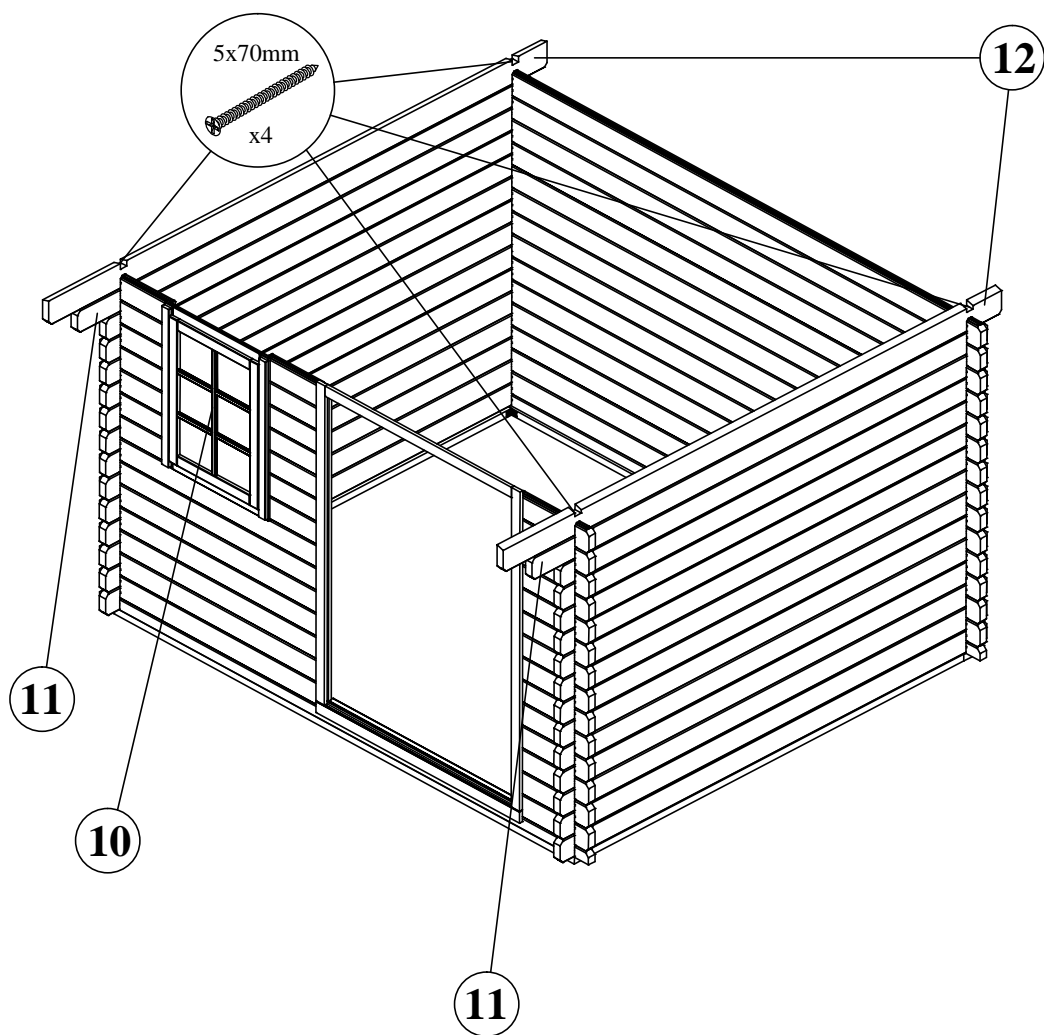
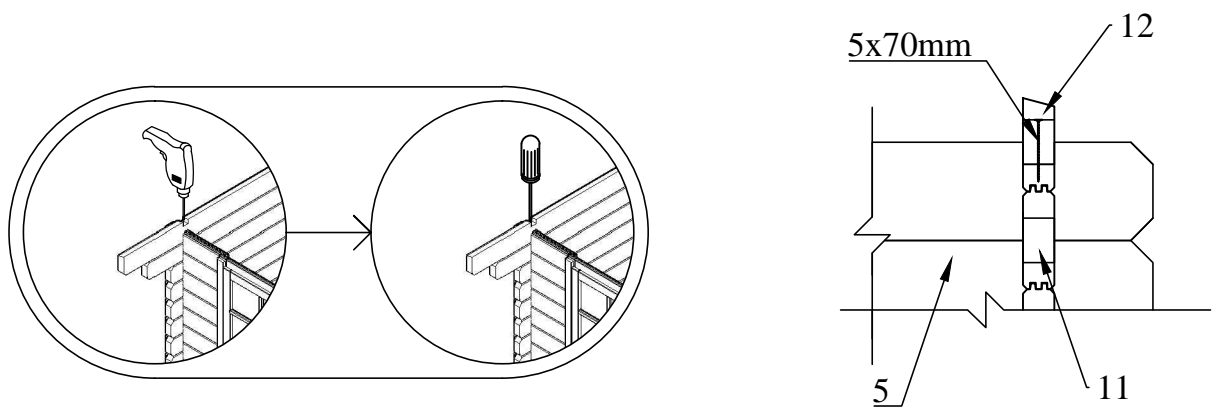

Nr.	Abmessungen (mm)	Menge
10	1035 x 775	1
11	2630 x 135 x 34	2
12	2980 x 135 x 34	1+1

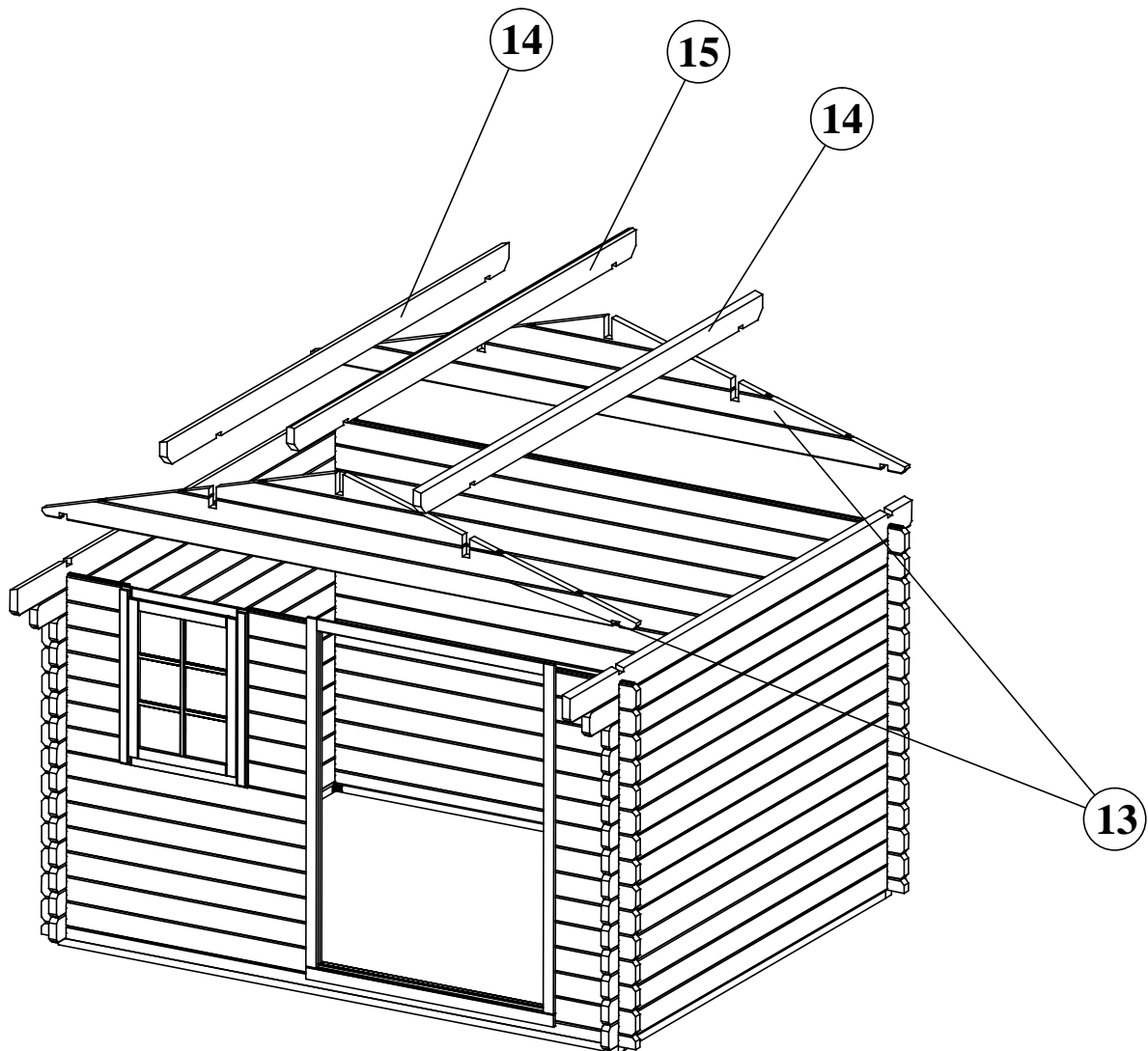

Nr.	Abmessungen (mm)	Menge
13	3477 x 534 x 34	2
14	2980 x 140 x 44	1+1
15	2980 x 140 x 44	1

Befestigung von Dachsparren

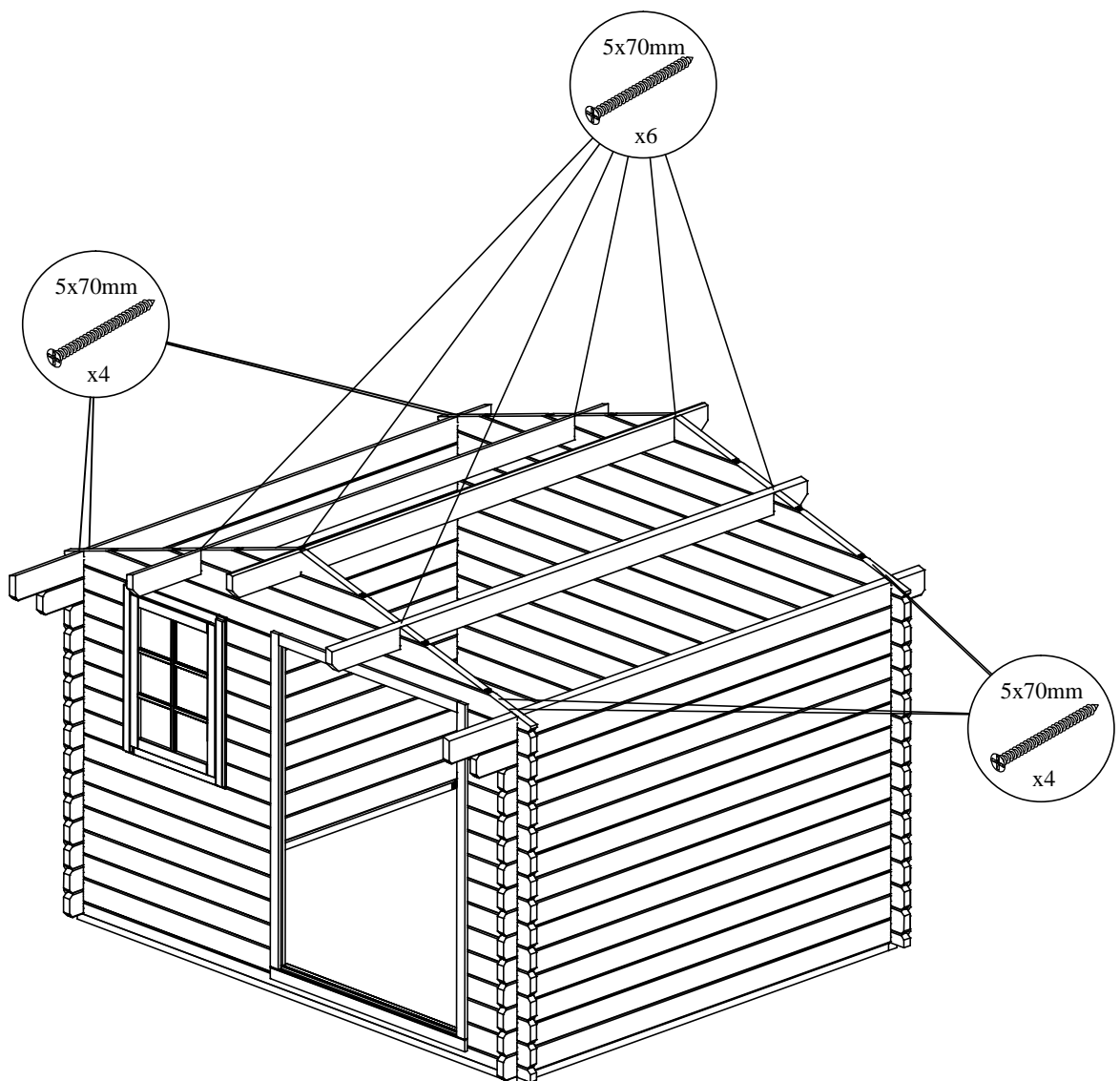
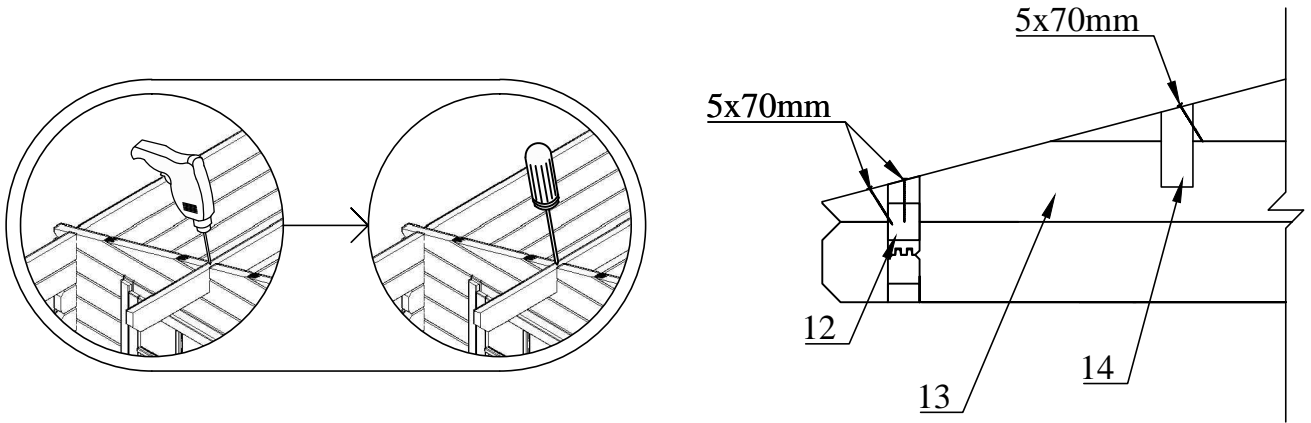

Die Installation der Sturmflut Streifen

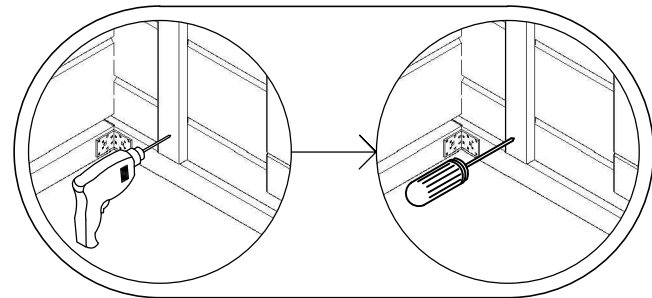
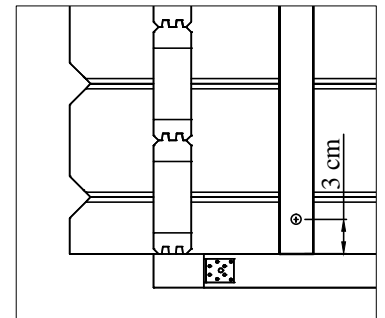
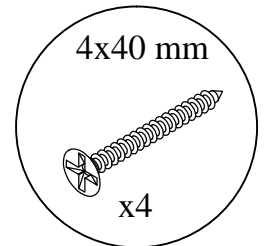
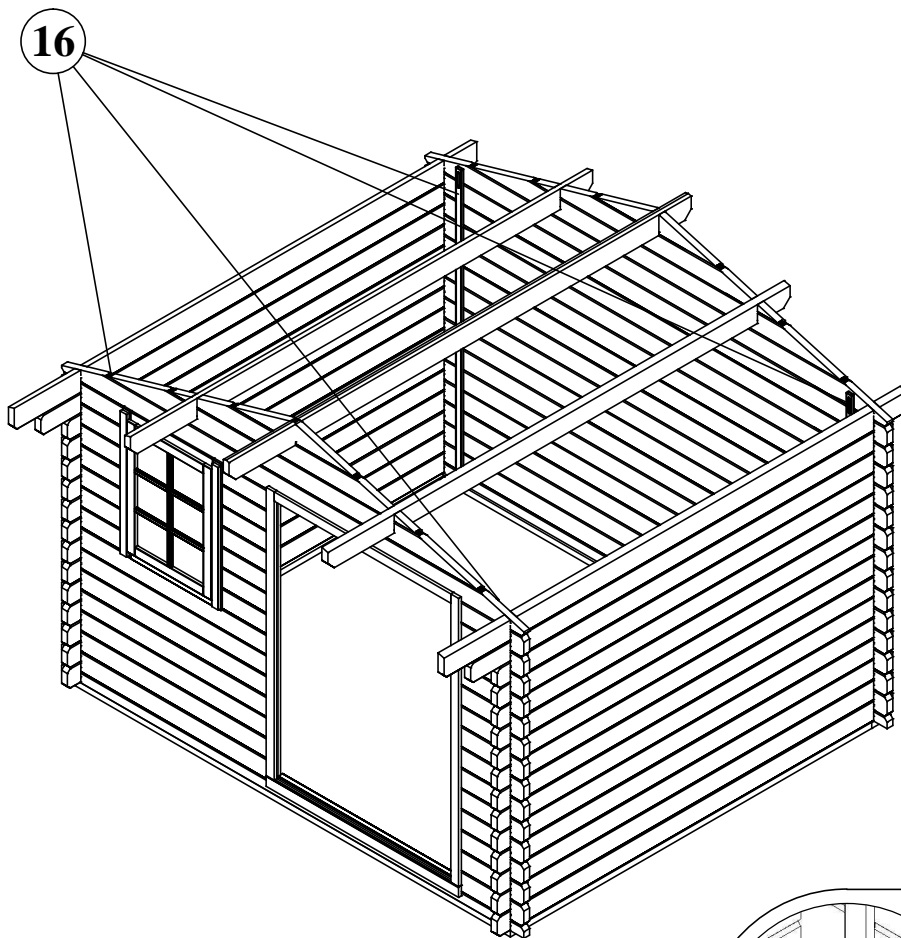
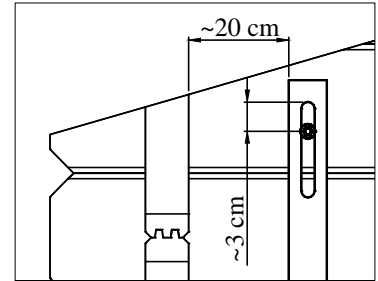
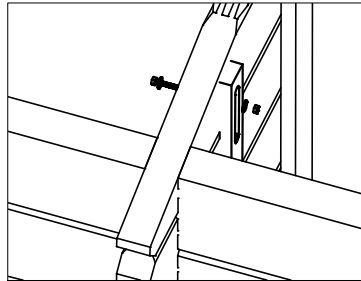
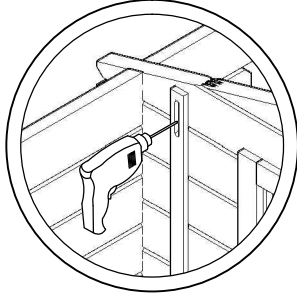
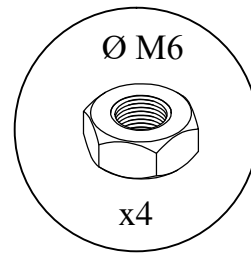
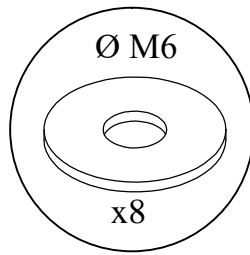
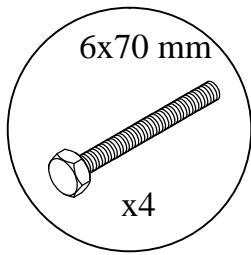

Nr.	Abmessungen (mm)	Menge
16	2030 x 40 x 16	4

Dachlattung

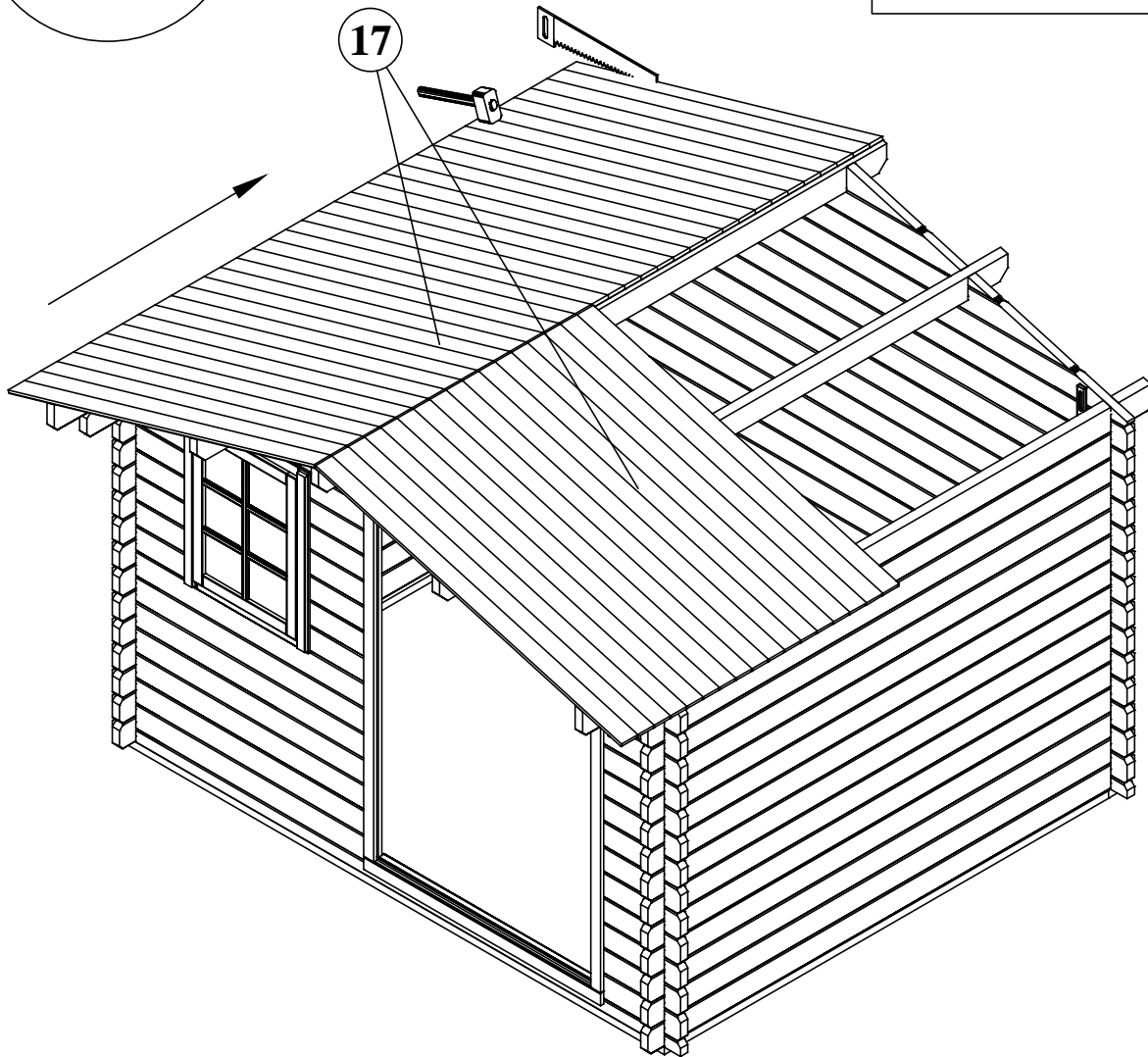
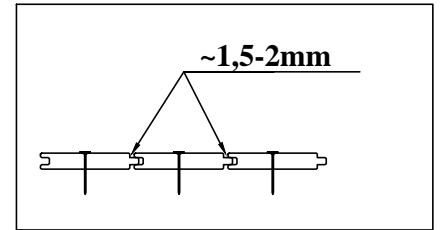
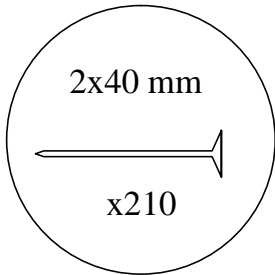
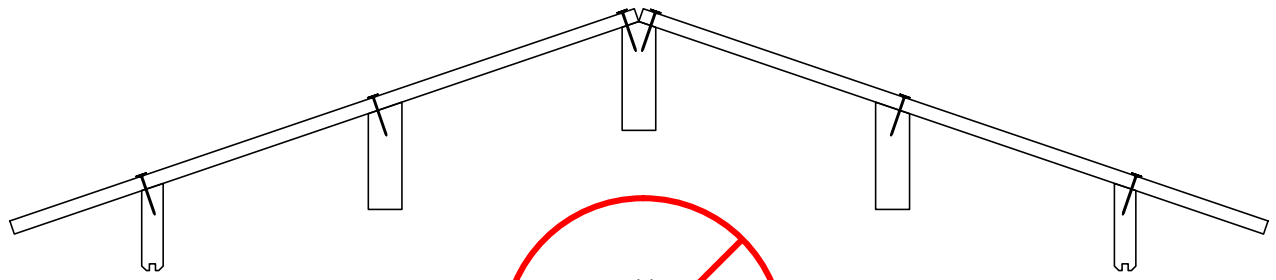

Mark	Abmessungen (mm)	Menge
17	1950 x 88 x 17	68 (+2)

Dacheindeckung

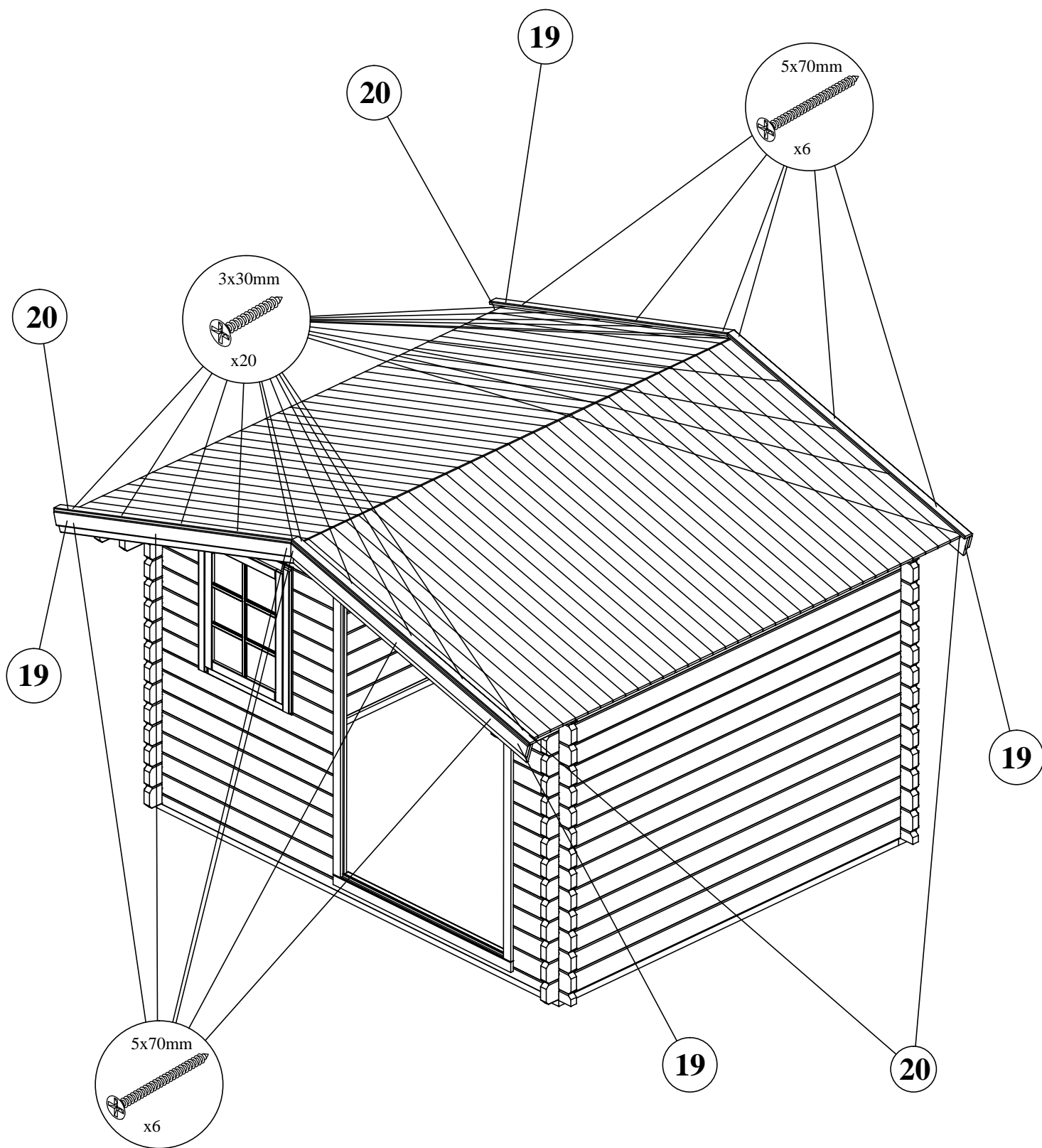

Nr.	Abmessungen (mm)	Menge
19	1995 x 120+90 x 19	2+2
20	1995 x 60 x 19	4

Dacheindeckung

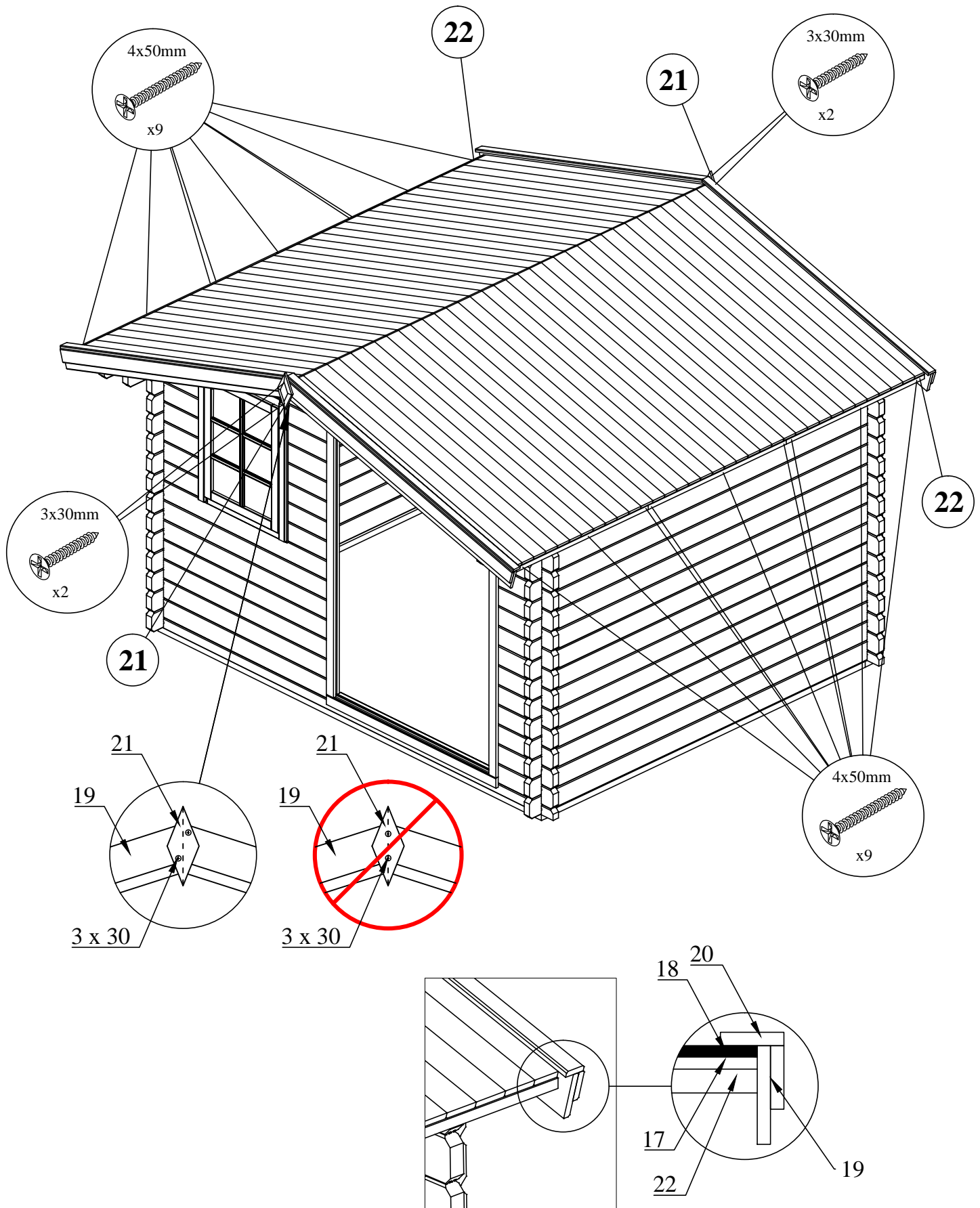

Nr.	Abmessungen (mm)	Menge
21	220 x 100 x 19	2
22	993 x 40 x 40	6

Dacheindeckung

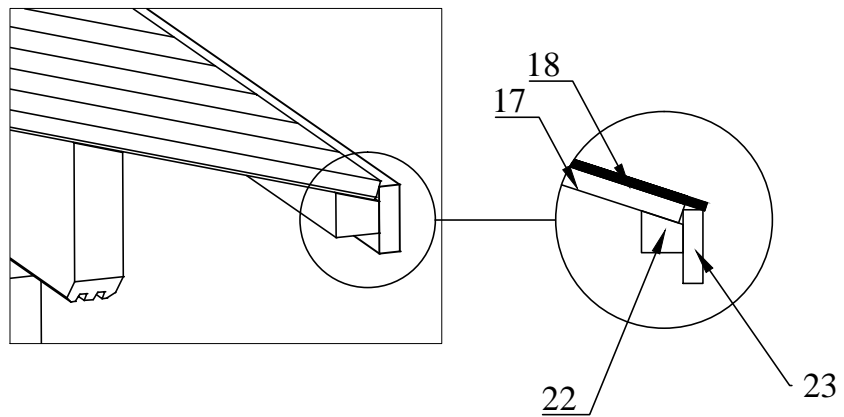
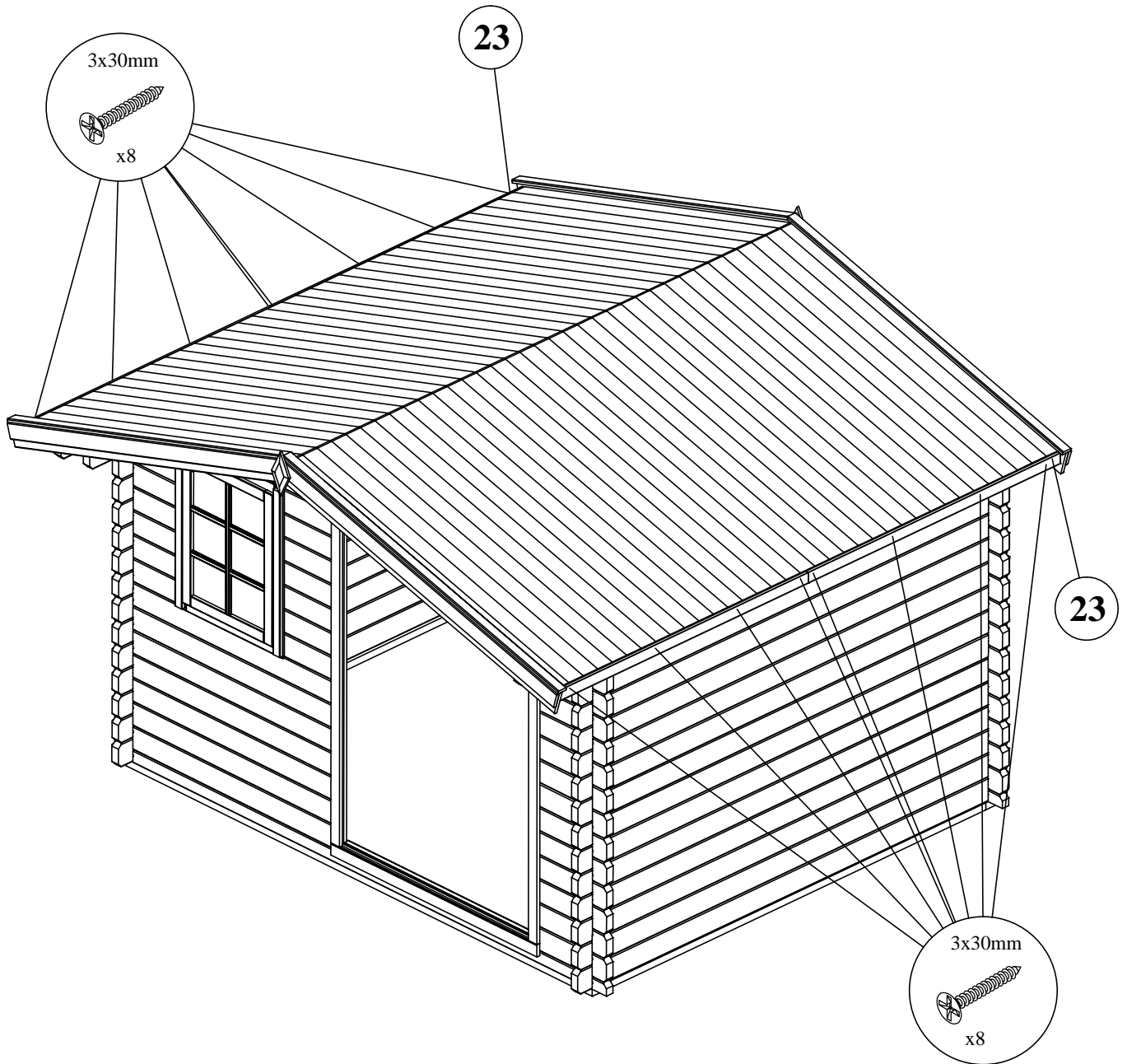

Nr.	Abmessungen (mm)	Menge
23	1490 x 60 x 19	4

Montage von Türen

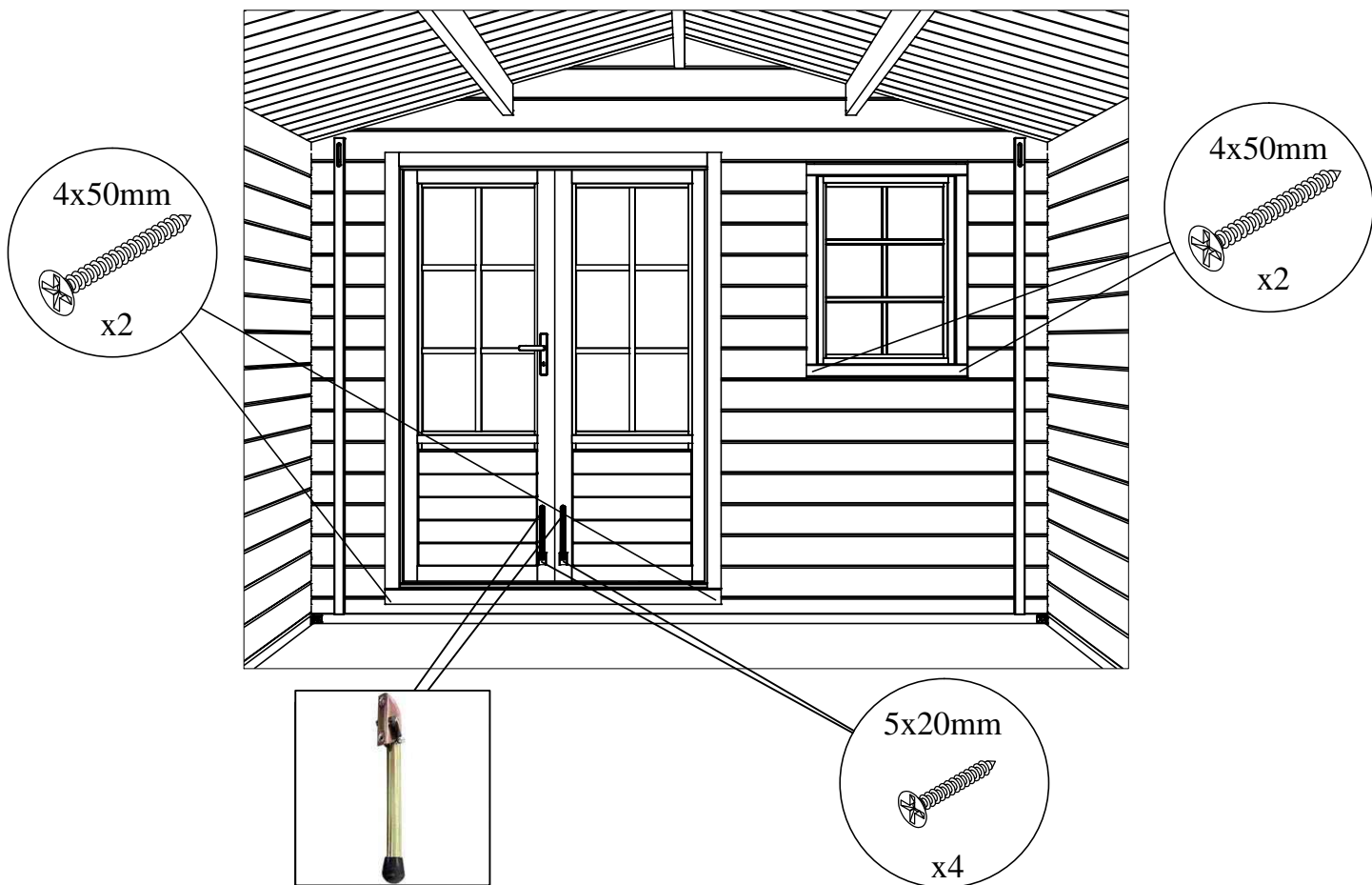
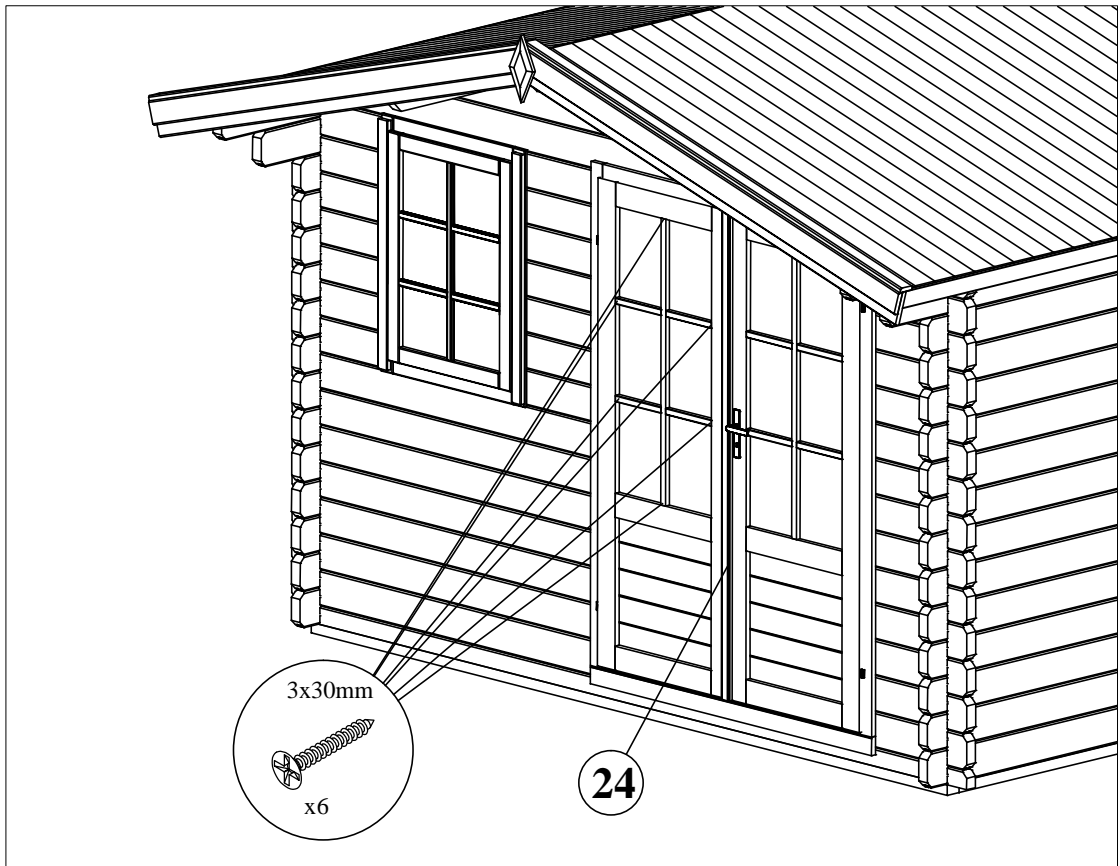

Nr.	Abmessungen (mm)	Menge
24	1775 x 660	1 + 1